

PTS-WM-VX805-VX820

Installation Instructions

Innovative Ergonomic Solutions companies

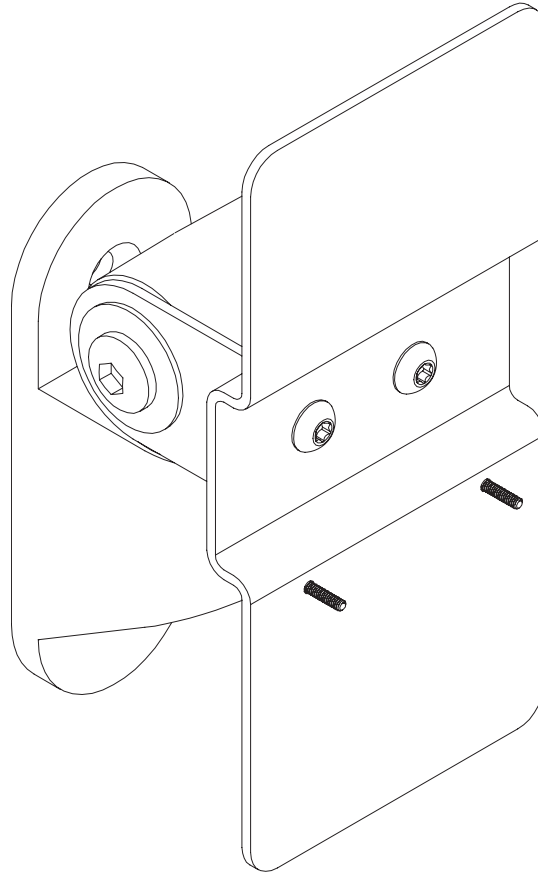

PTS-WM-VX805-VX820

Parts List

A



Wall Mount 1x
RP406795

B

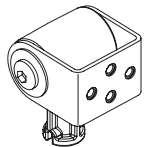

Mini Tilter 1x
416267

C

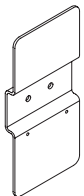

Verifone VX805/VX820 Adapter Plate 1x
114636

D



Tilt Bracket Screw 2x
113900

E

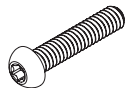

M2-0.4 x 10mm Button Head Torx Screw 2x
714773

F

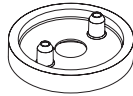

Dog Washer 1x
105189

G



10-32 x 3/8" FPhMS w/Lock Patch 1x
705198

H



T6 L-Key 1x
714897

I

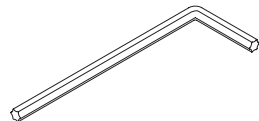

T25 L-Key 1x
714899

J

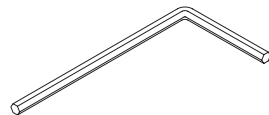

7/32" Allen Wrench 2x
701127

1

