

MNPA10-P200-P400

Installation Instructions

Innovative Ergonomic Solutions companies

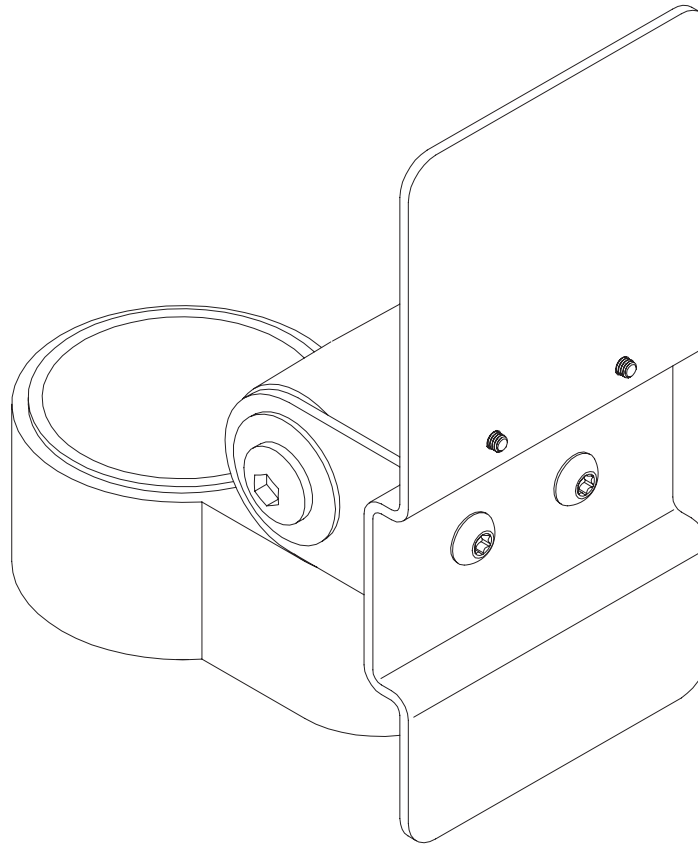

MNPA10-P200-P400

Parts List

A Mount Yoke 1x
414351

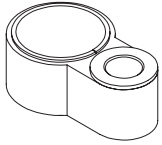

F Dog Washer 1x
105189

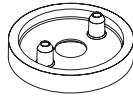

K 7/32" Allen Wrench 2x
701127

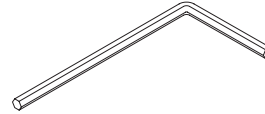

B Mini Tilter 1x
416267

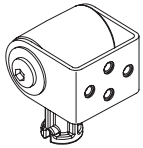

G 10-32 x 3/8" FPhMS w/Lock Patch 1x
705198



C Verifone P200/P400 Adapter Plate 1x
114856

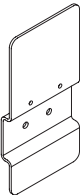

H T10 L-Key 1x
714898

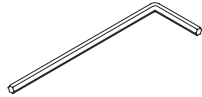

D Tilt Bracket Screw 2x
113900



I T25 L-Key 1x
714899

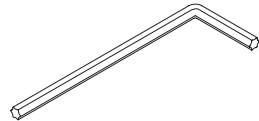

E M3-0.5 x 6mm Button Head Screw 2x
715251



J 3/32" Allen Wrench 1x
700146



1

