

# MNPA10-8500I

## Installation Instructions

Innovative Ergonomic Solutions companies

---

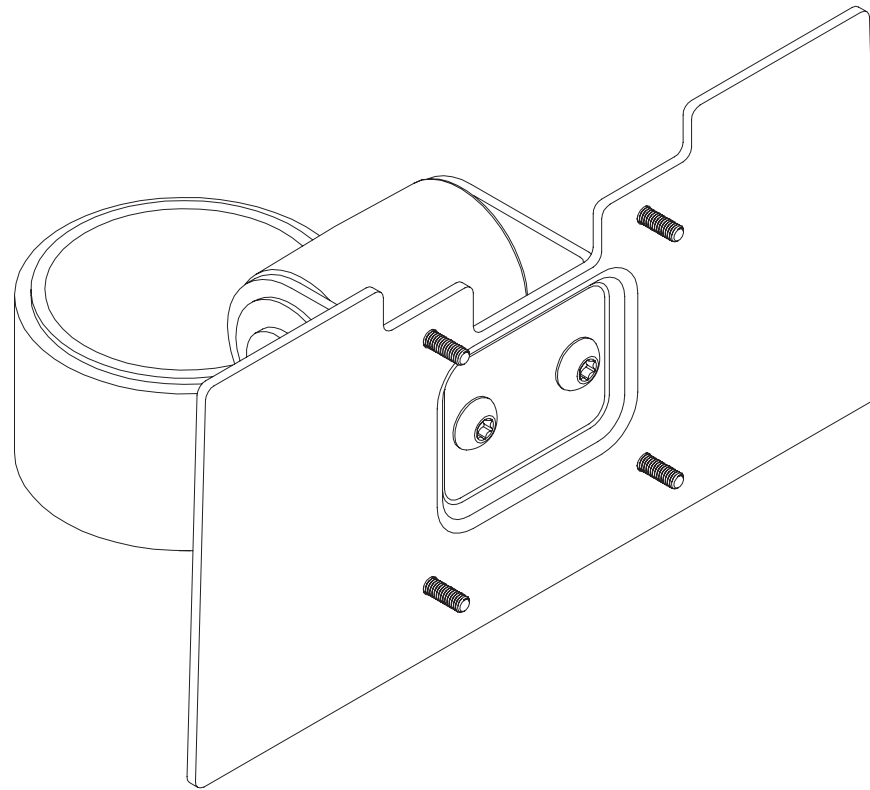

# MNPA10-8500I

## Parts List

A Mount Yoke 1x  
414351

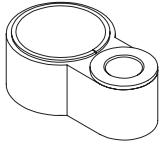

B Mini Tilter 1x  
416267

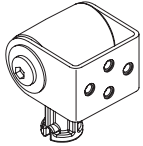

C Equinox 8500I Adapter Plate 1x  
114473

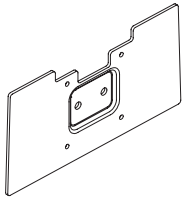

D Tilt Bracket Screw 2x  
113900



E M3-0.5 x 10mm Button Head Screw 4x  
714485



F Dog Washer 1x  
105189

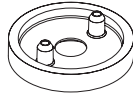

G 10-32 x 3/8" FPhMS w/Lock Patch 1x  
705198



H T10 L-Key 1x  
714898



I T25 L-Key 1x  
714899

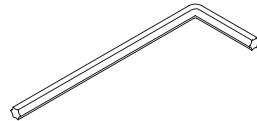

J 3/32" Allen Wrench 1x  
700146



K 7/32" Allen Wrench 2x  
701127

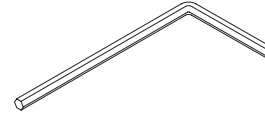

1

