

# MNPA10-6200M

## Installation Instructions

Innovative Ergonomic Solutions companies

---

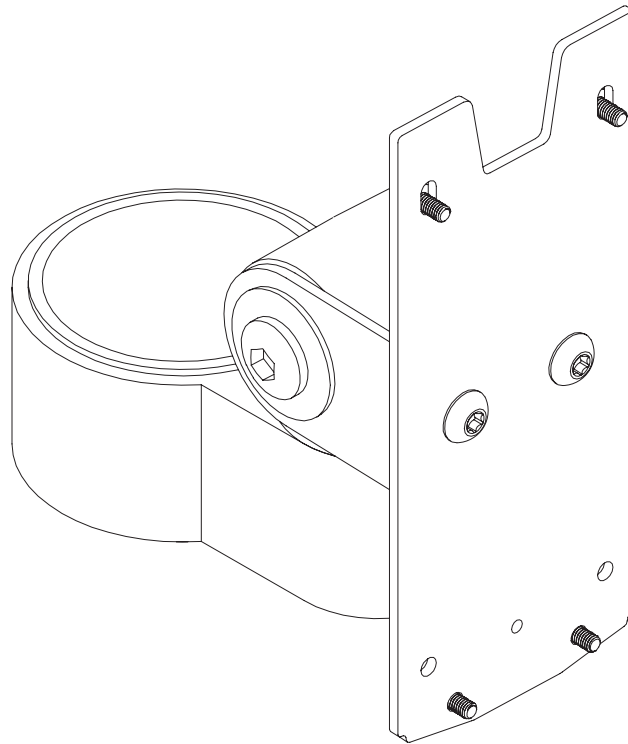

**Innovative Ergonomic Solutions**

800 524 2744

customerservice@team-ies.com

team-ies.com

# MNPA10-6200M

## Parts List

A Mount Yoke 1x  
414351

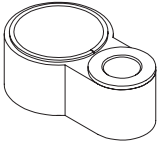

B Mini Tilter 1x  
416267

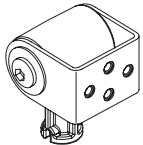

C Equinox 6200M Adapter Plate 1x  
115097

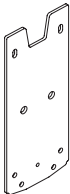

D Tilt Bracket Screw 2x  
113900



E M3-0.5 x 6mm Button Head Screw 4x  
715251



F Dog Washer 1x  
105189

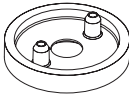

G 10-32 x 3/8" FPhMS w/Lock Patch 1x  
705198



H T10 L-Key 1x  
714898



I T25 L-Key 1x  
714899

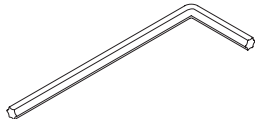

J 3/32" Allen Wrench 1x  
700146



K 7/32" Allen Wrench 2x  
701127

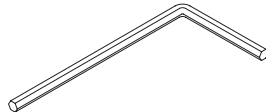

1

