

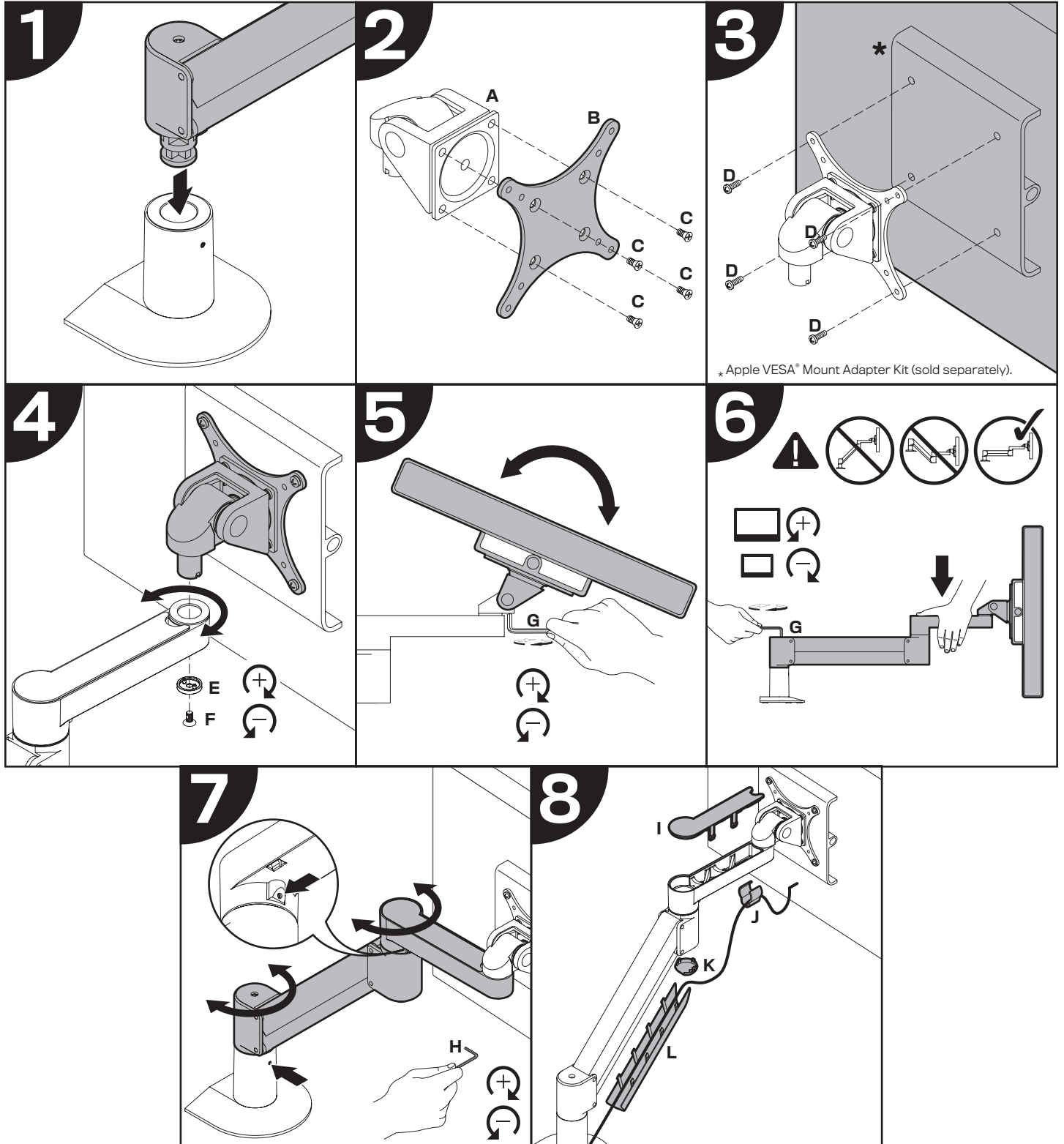

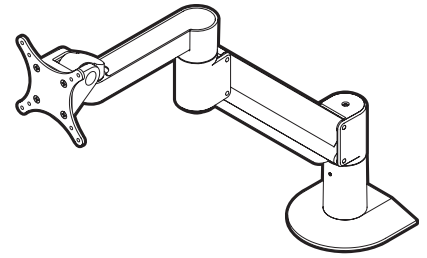



Innovative Ergonomic Solutions companies

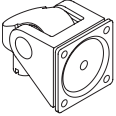

# iLIFT™

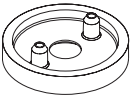

\* Apple VESA® Mount Adapter Kit (sold separately).

# iLIFT™

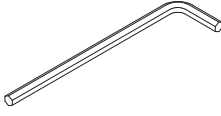
ITEM	DESCRIPTION / PART NO.
<b>A</b>	 <b>Spring-Assisted Monitor Tilter 1</b> 407747
<b>B</b>	 <b>75/100mm VESA® Adapter Plate 1</b> 105587
<b>C</b>	 <b>10-32 x 3/8" Phillips Flat Head Screw 1</b> 702281 (4-pack)
<b>D</b>	 <b>M4 x 12mm Phillips Pan Head Screw 1</b> 702096 (4-pack)
<b>E</b>	 <b>Dog Washer 1</b> 105189
<b>F</b>	 <b>10-32 x 3/8" FPhMS w/Lock Patch 1</b> 705198

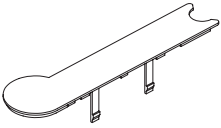
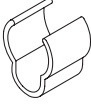
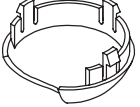
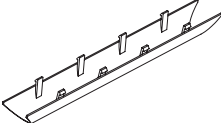
ITEM	DESCRIPTION / PART NO.
<b>G</b>	 <b>7/32" Allen Wrench 1</b> 701127
<b>H</b>	 <b>3/32" Allen Wrench 1</b> 700146
<b>I</b>	 <b>Forearm Cap 1</b> 109597-708
<b>J</b>	 <b>Cable Clip 1</b> 104533
<b>K</b>	 <b>Endcap Bumper 1</b> 702829
<b>L</b>	 <b>Cable Cap 1</b> 109344