

9130-D

MONITOR ARMS

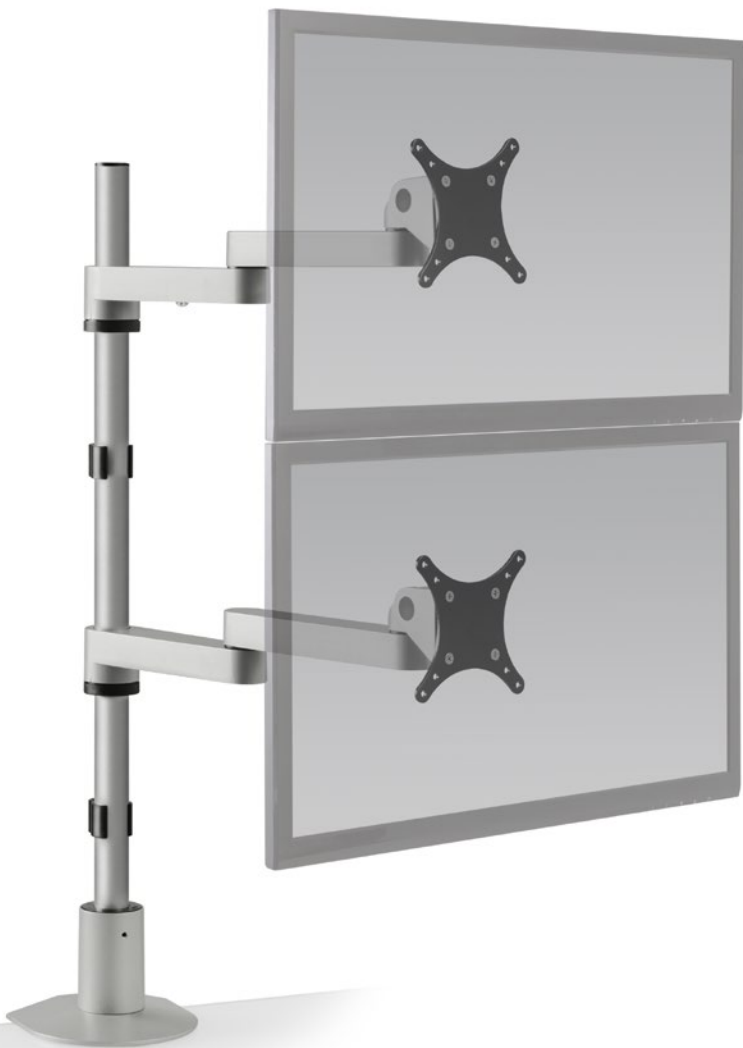

SPACE-SAVING ERGONOMIC COMFORT.

The 9130-S long reach monitor mount features a foldable arm that adjusts vertically up and down along the 28" pole mount. The monitor arm can fold to fit about 3" of space and extend out 16". There are various pole lengths available, or the monitor arm can be designed to fit any application you may be looking for.





FEATURES

- **Adjustable:** Friction control system provides smooth adjustment while adjusting the position of the dual monitor arms.
- **Flexible:** Monitor mount includes FLEXmount with six mounting options in one kit.
- **Space:** The monitor arm can fold to fit in approximately 3" of space and extend out 16".
- **Customizable:** Optional upgrade to quick install/release monitor bracket; consult your sales rep for details.
- **Compatible:** VESA-monitor compatible – 75mm & 100mm VESA adapters included.

SPECIFICATIONS

Finishes

	Silver 124
	Vista Black 104

Dimensions

Screen Size: Up to 32"
 Height Adjustment: Adjusts anywhere along pole
 Extension Range: 16"
 Weight Capacity: Up to 40 lbs. per monitor
 Mount: Desk Edge, Thru-Desk, Grommet, Wall, Reverse Wall, Side Bolt

Part Numbers

9130-D-28-FM-___

WARRANTY

10 years



Integrated cable management

Focal depth adjustment

Space-saving design

CAPABILITIES

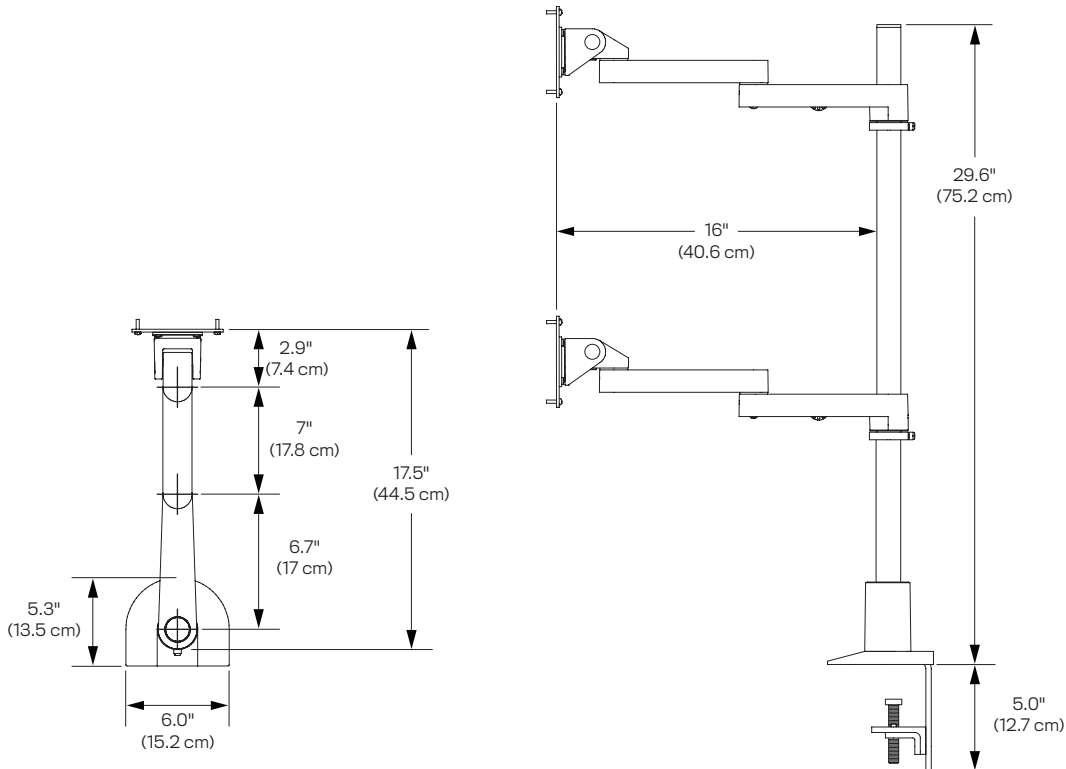

Desk Edge



Thru-Desk

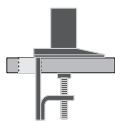

Grommet



Wall

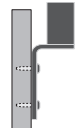

Reverse Wall

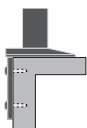

Side Bolt